

INSTALLATION MANUAL



VR ULTRALITE

**EXTENSIVE
EXTRA LIGHTWEIGHT BUILT-UP SYSTEM**

VR ULTRALITE

**1 Root Barrier Layer:
 VR RootBloc 10, VR RootBloc 20, or
 VR RootBloc 40**

(NOTE: For both conventional & inverted roof assemblies.)

- a. Install root barrier layer over the roofing membrane. Lap all joints by a minimum 4" (100 mm).

For VR RootBloc 10 or VR RootBloc 20, seal all seams continuously with VR TecTape 2, or with heat welding.

For VR RootBloc 40, seal all seams continuously with VR TecTape 4 or with heat welding.

- b. Bring the root barrier up all projections and parapets within the designated green roof area, at least 1" (25 mm) above the finished vegetation level. Secure with VR TecTape 2 or VR TecTape 4 respectively, creating an uninterrupted seal between the root barrier and the projections or parapets within the designated green roof area.

When installing VR RootBloc 40, DO NOT pull too tightly at corners, to allow the material room to expand and contract with temperature.

VR RootBloc 40 must be secured to parapets with VR TecTape 4 or termination bars.

- c. In the case of roof drains, remove the drain grate and ensure the root barrier extends beyond the edge of the clamping flange. Cut a hole in the root barrier that is sufficient in size to allow for uninterrupted drainage. Clamp the grate back onto the clamping flange.

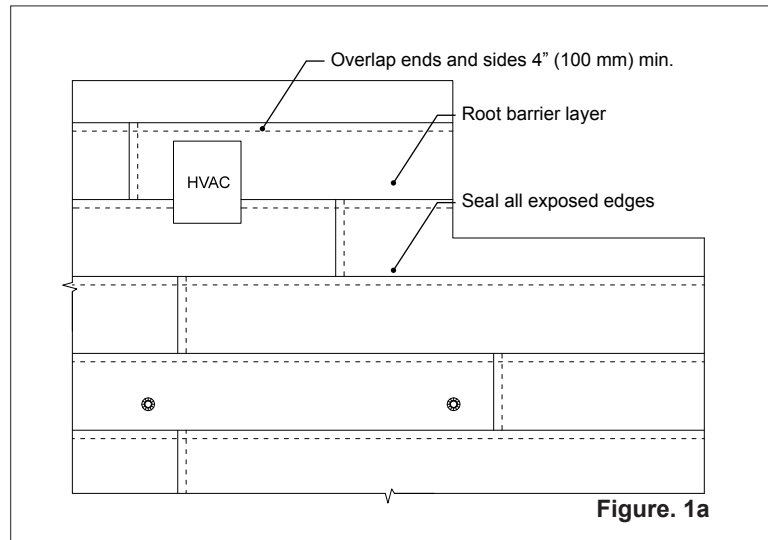

Figure. 1a

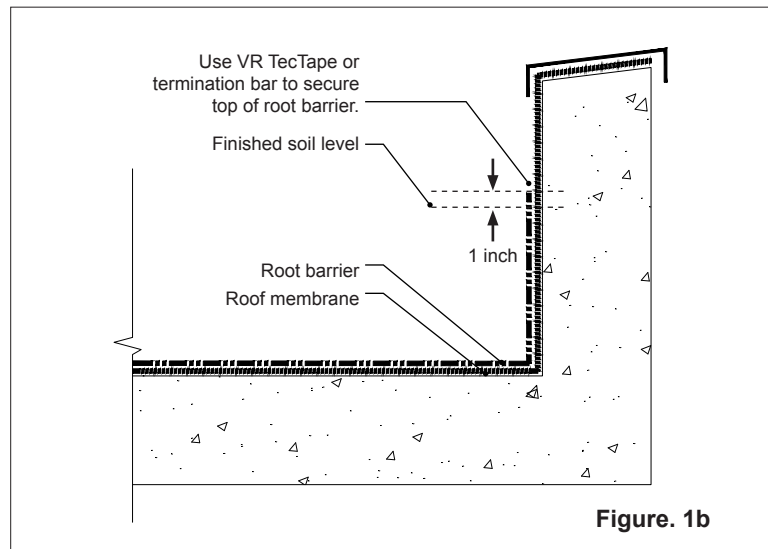

Figure. 1b

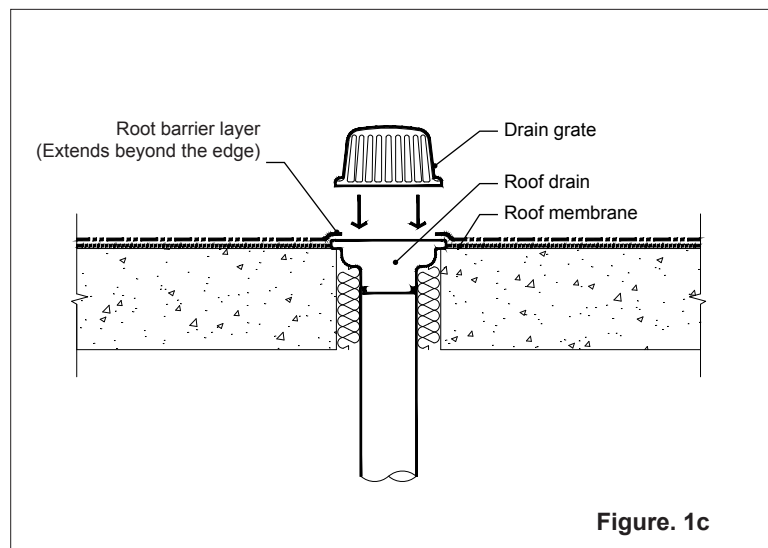
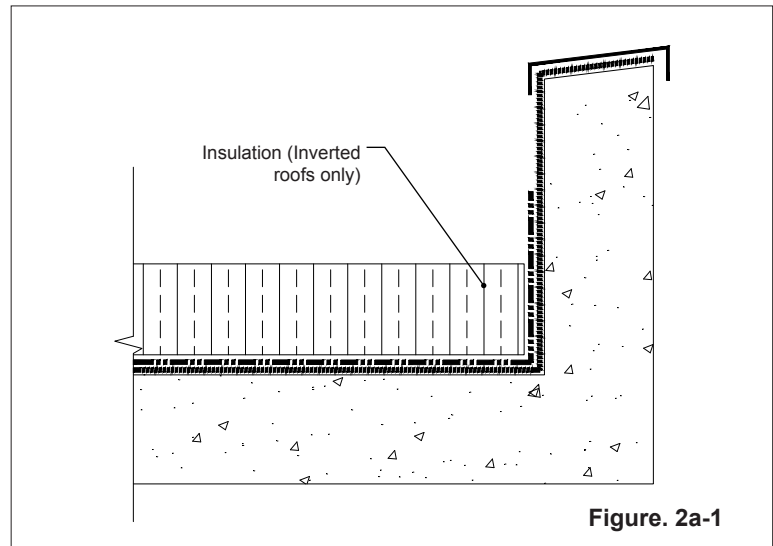

Figure. 1c

**2 Insulation
(Option 1)**

(NOTE: This step is required if an inverted roof system is used. Otherwise proceed to Option 2.)

- a. Lay insulation in parallel courses, staggering end laps and side laps. Do not force into place.



- b. Cut insulation to fit neatly at projections and terminations with less than 1" (25 mm) tolerance.

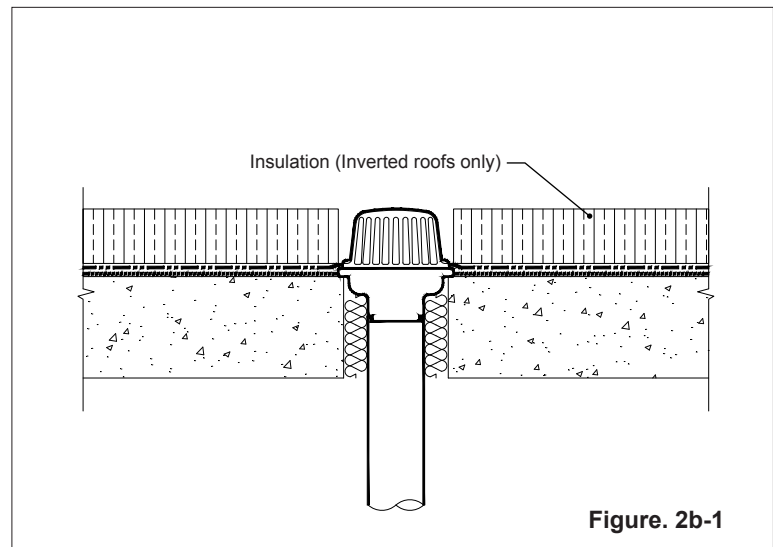

**2 Protection Sheet:
VR PolyMat (Option 2)**

(NOTE: This step is required if a conventional roof system is used.)

- a. Lay VR PolyMat over the root barrier layer and cut it to fit neatly at projections and terminations with less than 1" (25 mm) tolerance.

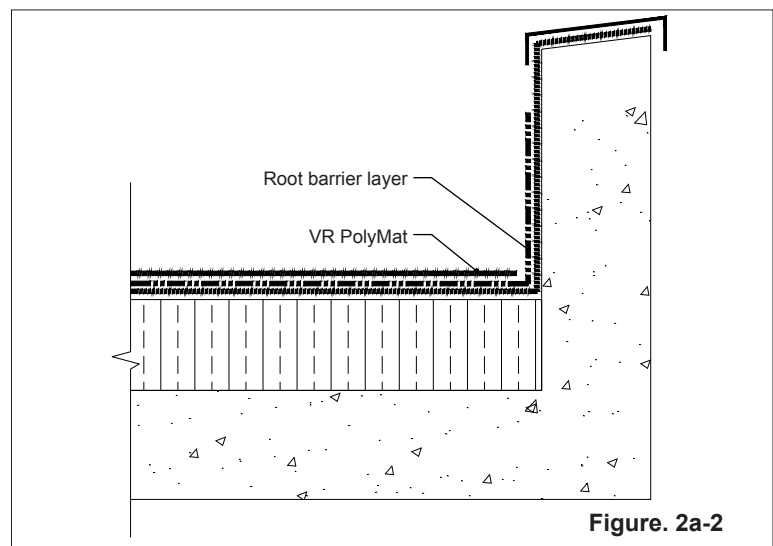

**3 Drain Inspection Chamber:
 VR DrainGuard**

(NOTE: This component is not required.
 Proceed to Step 4 if VR DrainGuard is not
 being used for this project.)

- a. Install VR DrainGuard centred over
 roof drains either on top of insulation
 (for inverted roofs) or
 VR PolyMat (for conventional roofs).
- b. Place lid over tabs, apply lock-out
 tags, ensuring they show the current
 date.

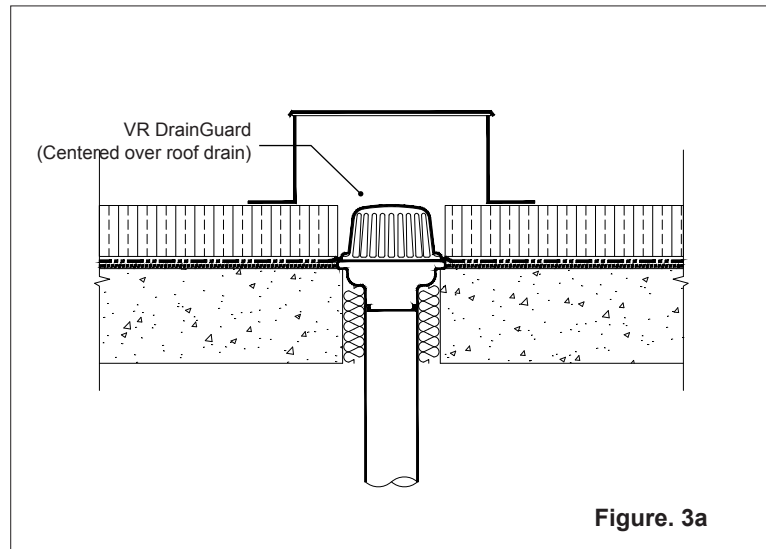

Figure. 3a

**4 Edging Restraint:
 VR EdgeGuard**

(NOTE: This component is not required.
 Proceed to Step 5 if the vegetation-free zone
 is being installed without VR EdgeGuard.)

- a. Install VR EdgeGuard along perimeter
 border between vegetation-free area
 and vegetated area as per plans and
 drawings.
- b. Ensure flange of edging restraint is
 facing the vegetation.

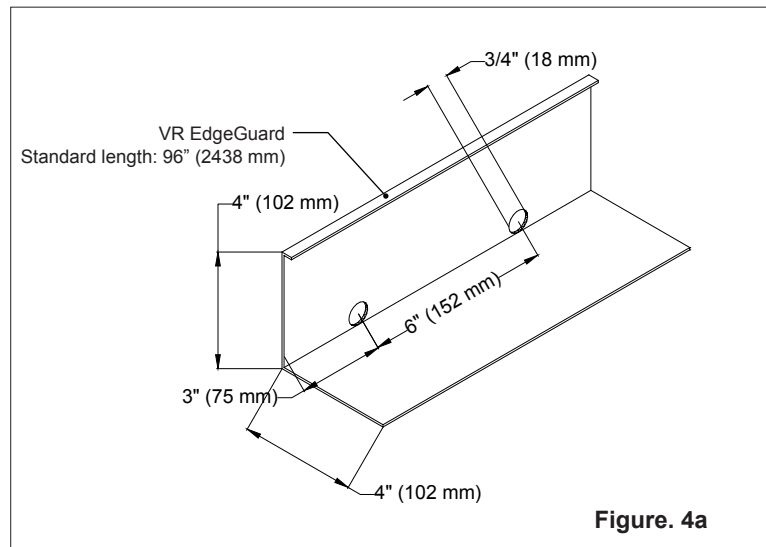

Figure. 4a

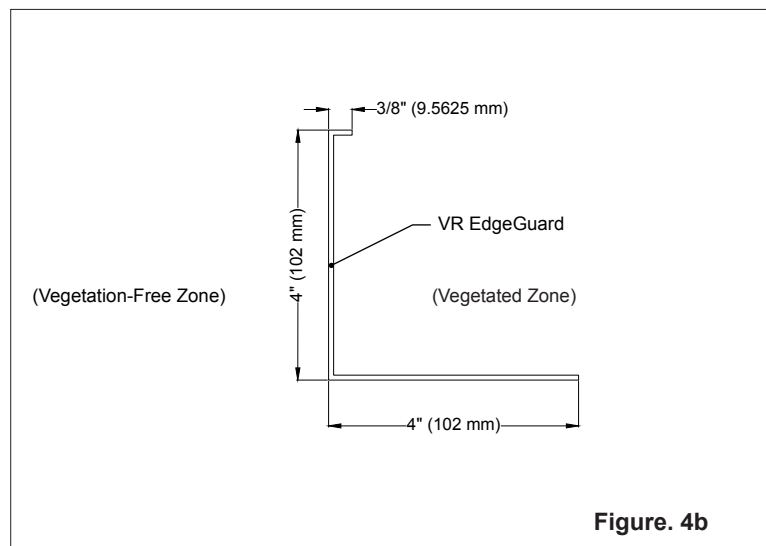
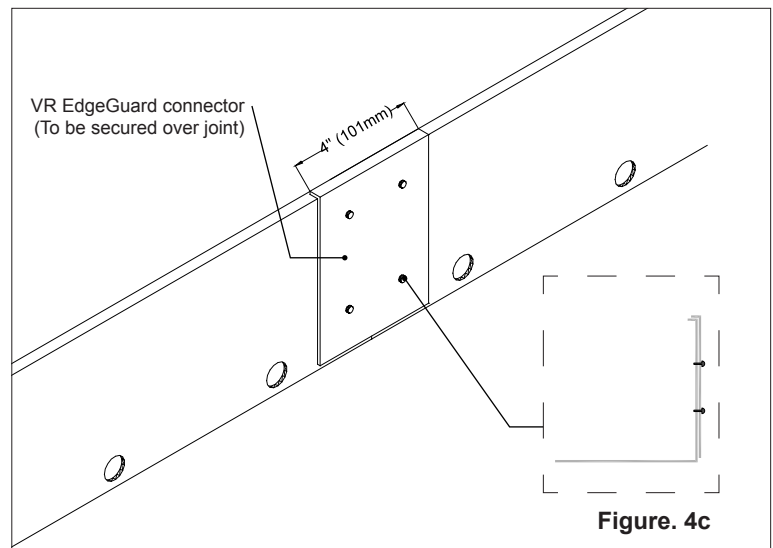
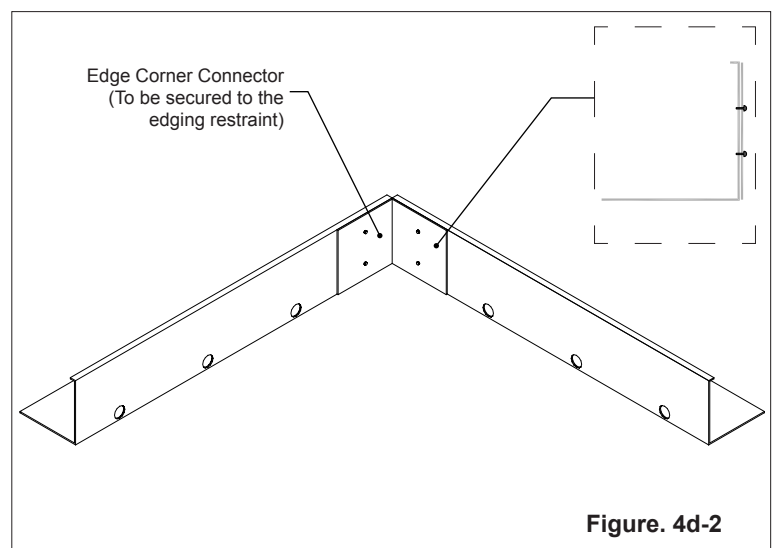
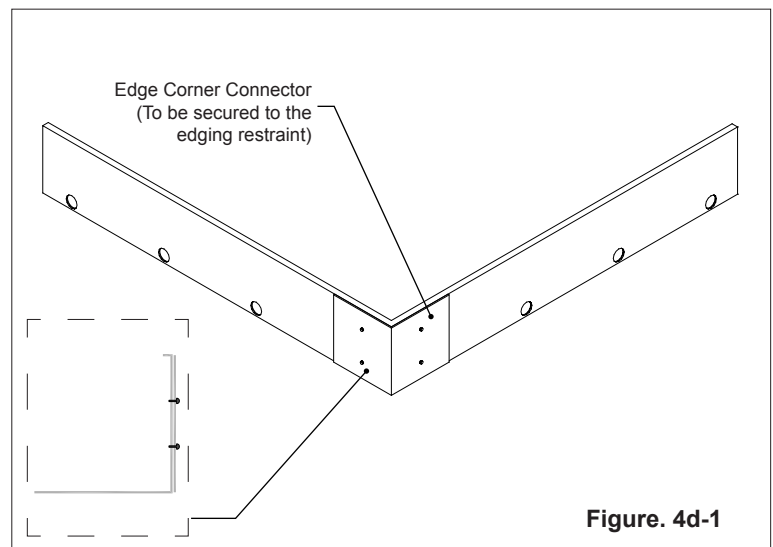

Figure. 4b

- c. When joining two sections together, ensure a tight fit at all joints. Place edge connector piece on vegetation-free side of edging restraint, making sure to overlap evenly with both ends of joints. Secure with self-tapping screws as per diagram. See Figure 4c.



- d. Install corners after long sections. Miter flange and lip of edging restraints at corners. Place edge corner connector on vegetation-free side of edging restraint, at the corners. Secure corner piece with self-tapping screws as per diagrams. See Figure 4d-1 for outside corners and Figure 4d-2 for inside corners.



5 Vegetation Free Zone Preparation
(Where no edging restraint is used)

- a. Place an additional horizontal layer of 2" (50 mm) polystyrene insulation around the perimeter of the green roof area.
- b. Ensure the additional layer covers the entire vegetation free zone area.
- c. When installing drainage layer and water retention layer, cut tightly around insulation at vegetation-free zones.

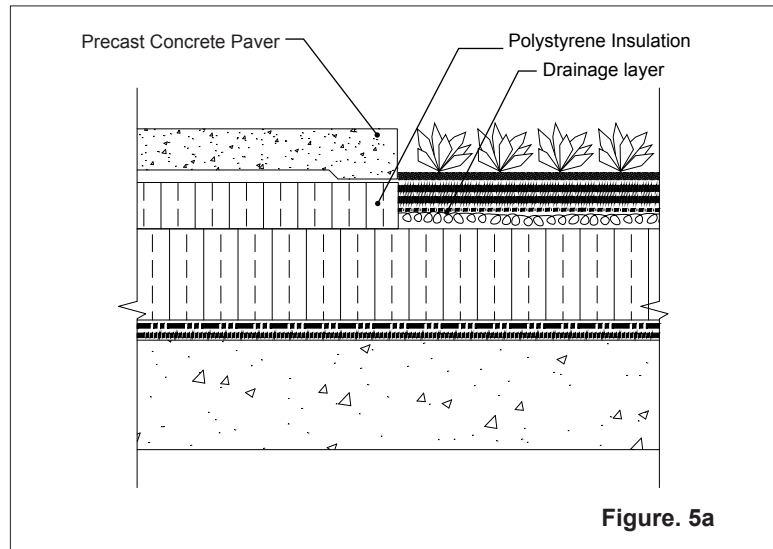

6 Drainage Layer:
VR AeroMat 0.75

- a. Lay VR AeroMat 0.75 sheets, fabric side up, over the base layer of insulation up to the additional layer of insulation in the vegetation free zone, cutting around all projections and edging restraint for a tight fit.
- b. Butt sides and ends together using fabric end lap to overlap adjacent layers.

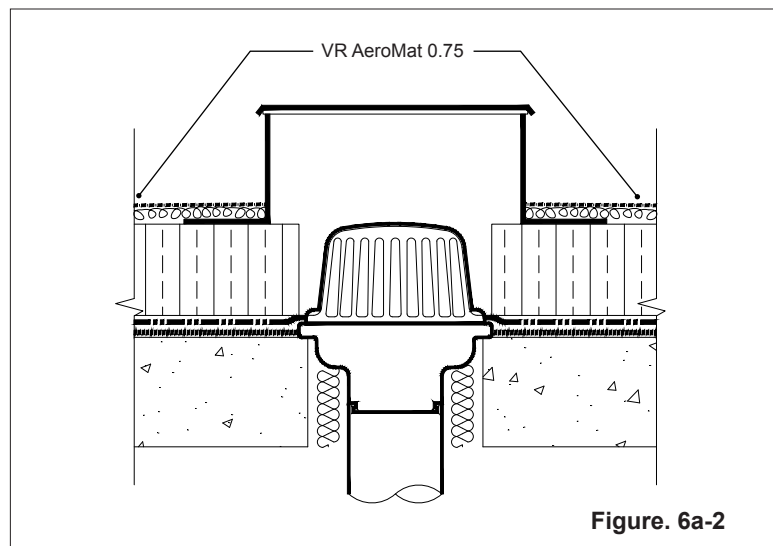
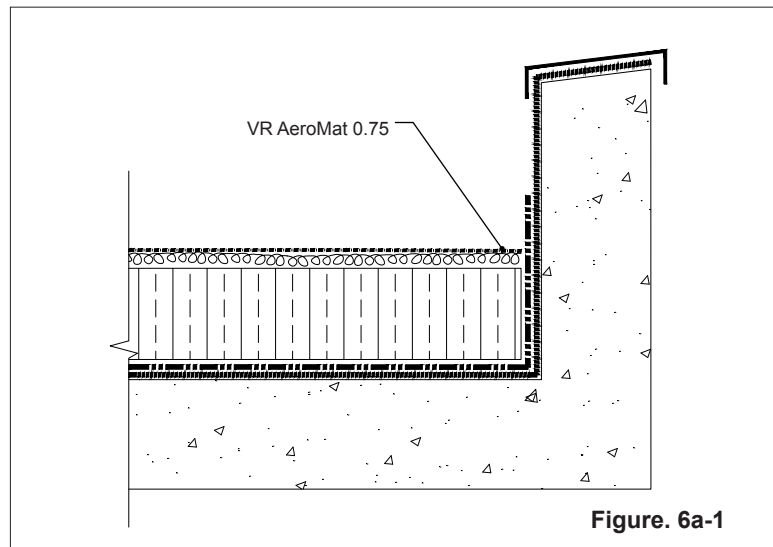

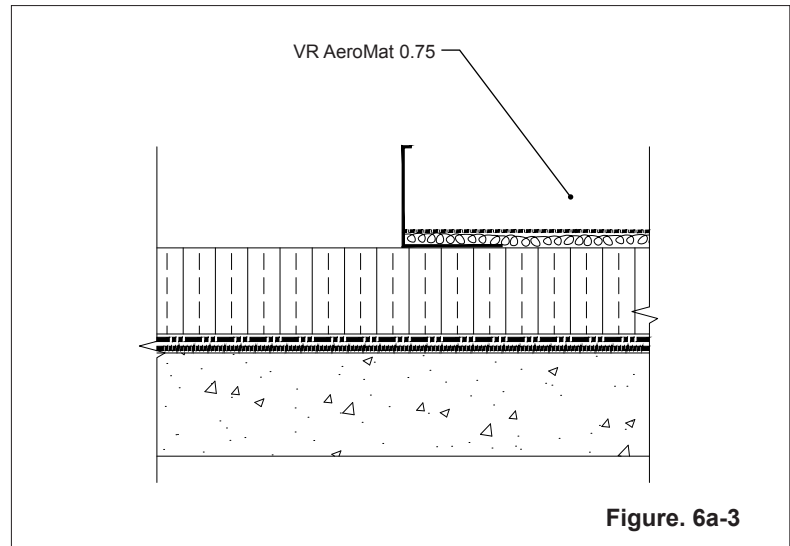

**7 Moisture Retention Layer:
VR MoistureMat**

- a. Install one layer of VR MoistureMat on top of VR AeroMat 0.75. Each row of adjacent mats shall be offset by at least 6.5 ft (2 m) to avoid alignment of end seams across rows.

Cut tightly around any projections, drains, etc.

Install a second layer of VR MoistureMat, either 90-degrees to the first layer, or in the same direction by offsetting the placement by half the width of the roll.

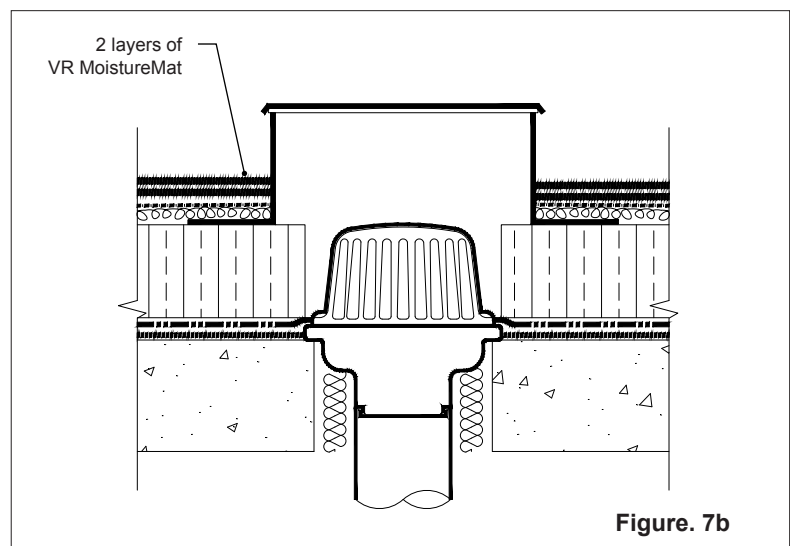
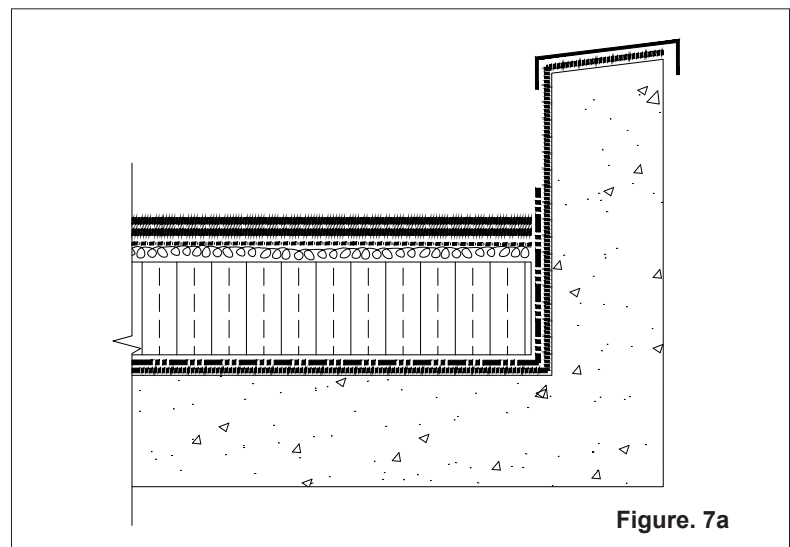

8 Drip Irrigation System

(NOTE: If irrigation is not required proceed to Step 9. Install irrigation prior to installing pre-cultivated vegetation mat.)

- a. Run drip irrigation lines over the top of the moisture retention layer as per plans and drawings.
- b. Place valves, valve boxes, controller(s), etc... as per plans and drawings.

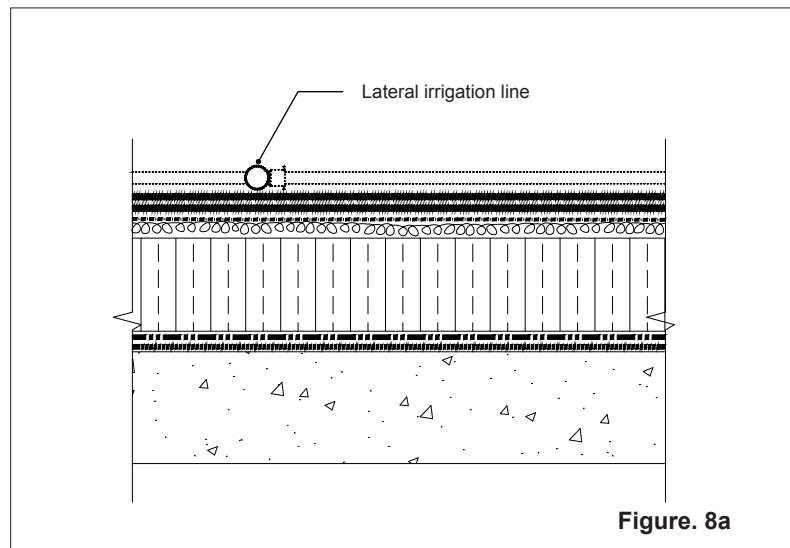

9 Vegetation: Sedum mat

- a. Install the pre-cultivated vegetation mat on top of the water retention layers. Offset vegetation mats by half the length of an individual mat to avoid alignment of end seams across rows. Cut to fit along roof edge and around penetrations.
- b. After installation of mats, redistribute and/or supplement the substrate accordingly to ensure even coverage across vegetation mats. In areas or alongside edges where substrate is lost during transport and handling, new substrate must be added to support vegetative growth.
- c. Water the assembled vegetation system immediately and thoroughly after installation to assist with settling of system layers and to support vegetation establishment.

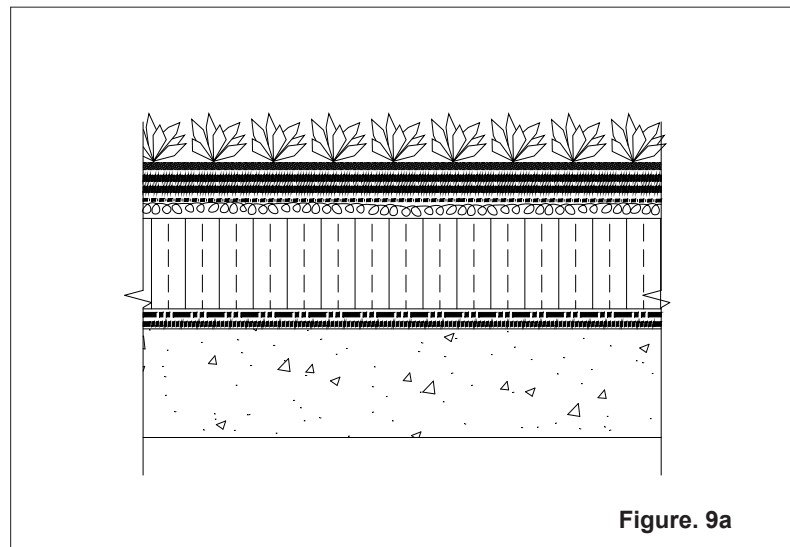

10 Vegetation-Free Zone Pavers

(OPTION 1: With built-in pedestal and edging restraint.)

- a. Place pavers tight against the VR EdgeGuard on top of the Insulation/Roofing System.
- b. Cut to fit as per plans and drawings.

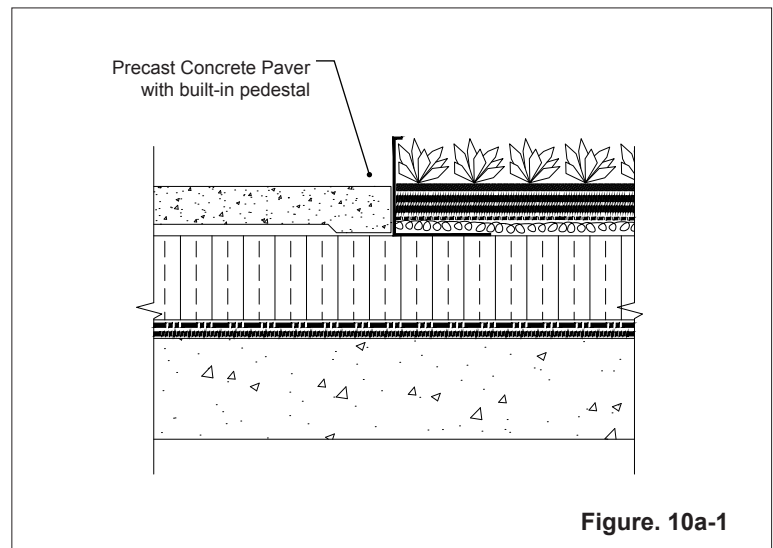

(OPTION 2: With separate pedestal and edging restraint.)

- a. Place pavers on pedestals directly on top of Insulation/Roofing System. Ensure tight fit against the VR EdgeGuard.
- b. Level pedestals as required to make sure top of paver is flush with top of edging restraint.
- c. Cut to fit as per plans and drawings.

