

*INSTALLATION MANUAL*



# **VR ULTRALITE PLUS**

**EXTENSIVE  
EXTRA LIGHTWEIGHT BUILT-UP SYSTEM**

VR ULTRALITE PLUS

**1 Root Barrier Layer:  
 VR RootBloc 10, VR RootBloc 20, or  
 VR RootBloc 40**

(NOTE: For both conventional & inverted roof assemblies.)

- a. Install root barrier layer over the roofing membrane. Lap all joints by a minimum 4" (100 mm).

For VR RootBloc 10 or VR RootBloc 20, seal all seams continuously with VR TecTape 2, or with heat welding.

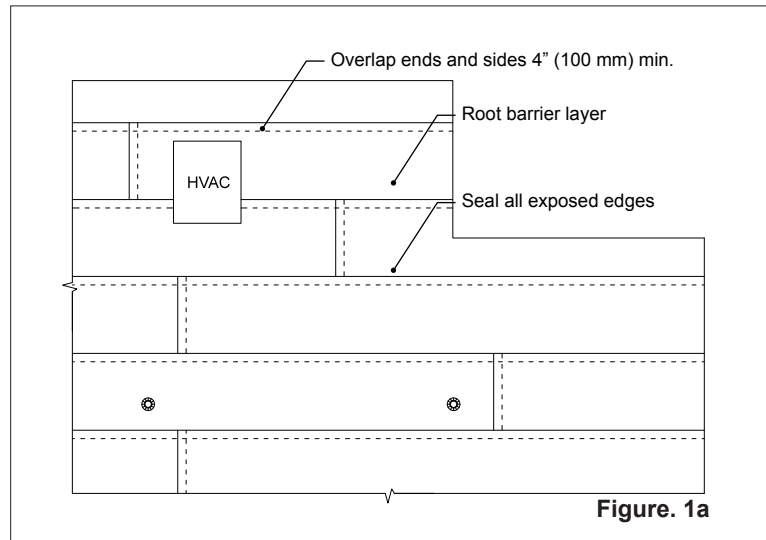
For VR RootBloc 40, seal all seams continuously with VR TecTape 4 or with heat welding.

- b. Bring the root barrier up all projections and parapets within the designated green roof area, at least 1" (25 mm) above the finished vegetation level. Secure with VR TecTape 2 or VR TecTape 4 respectively, creating an uninterrupted seal between the root barrier and the projections or parapets within the designated green roof area.

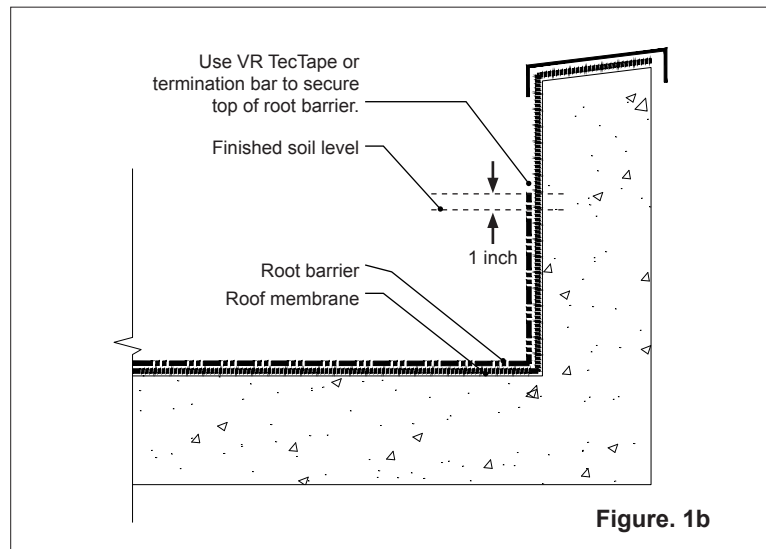
When installing VR RootBloc 40, DO NOT pull too tightly at corners, to allow the material room to expand and contract with temperature.

VR RootBloc 40 must be secured to parapets with VR TecTape 4 or termination bars.

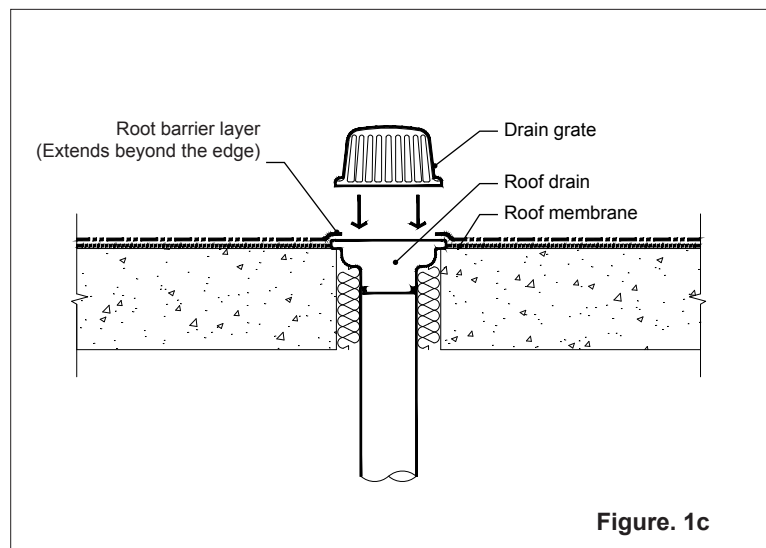
- c. In the case of roof drains, remove the drain grate and ensure the root barrier extends beyond the edge of the clamping flange. Cut a hole in the root barrier that is sufficient in size to allow for uninterrupted drainage. Clamp the grate back onto the clamping flange.



**Figure 1a**



**Figure 1b**

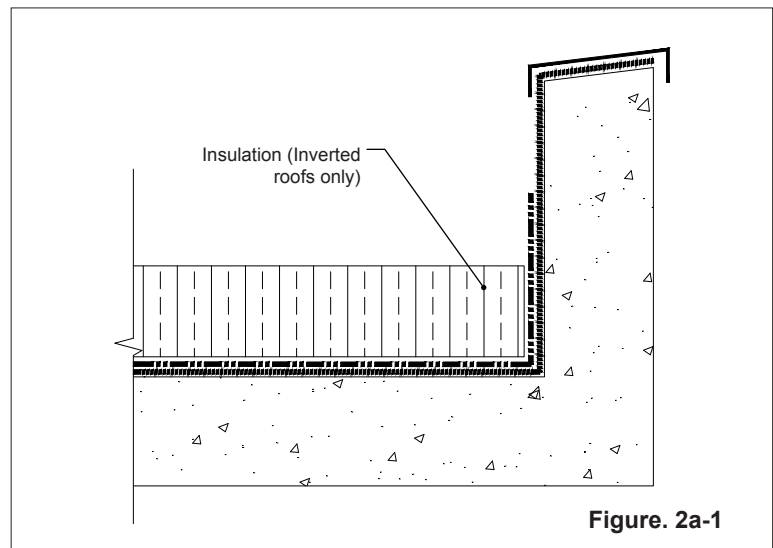


**Figure 1c**

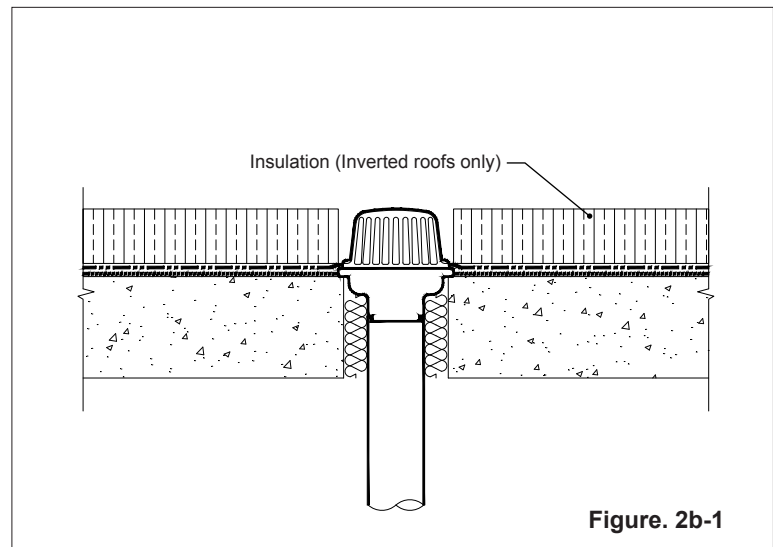
**2 Insulation  
(Option 1)**

(NOTE: This step is required if an inverted roof system is used. Otherwise proceed to Option 2.)

- a. Lay insulation in parallel courses, staggering end laps and side laps. Do not force into place.



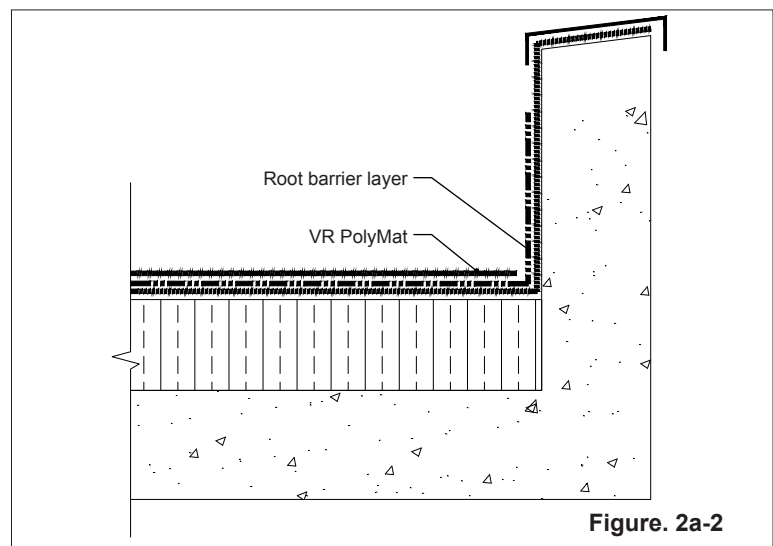
- b. Cut insulation to fit neatly at projections and terminations with less than 1" (25 mm) tolerance.



**2 Protection Sheet:  
VR PolyMat (Option 2)**

(NOTE: This step is required if a conventional roof system is used.)

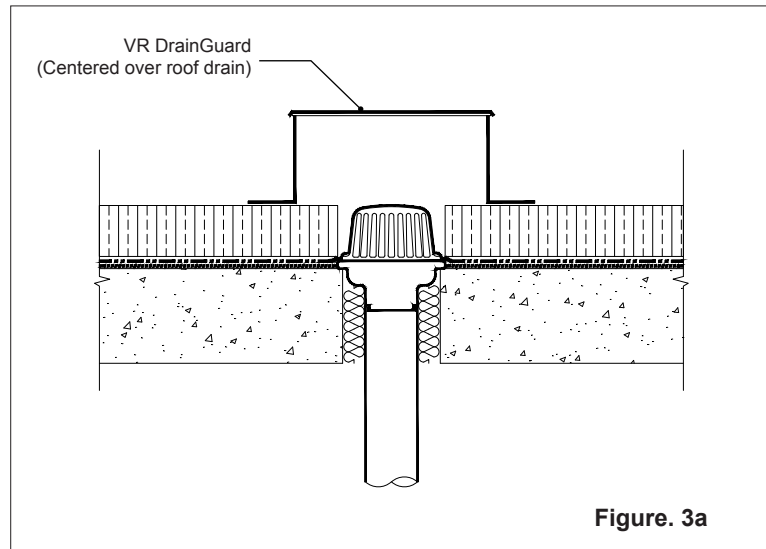
- a. Lay VR PolyMat over the root barrier layer and cut it to fit neatly at projections and terminations with less than 1" (25 mm) tolerance.



**3 Drain Inspection Chamber:  
 VR DrainGuard**

(NOTE: This component is only required for internal drains. Proceed to Step 4 if there are no internal drains present for this project.)

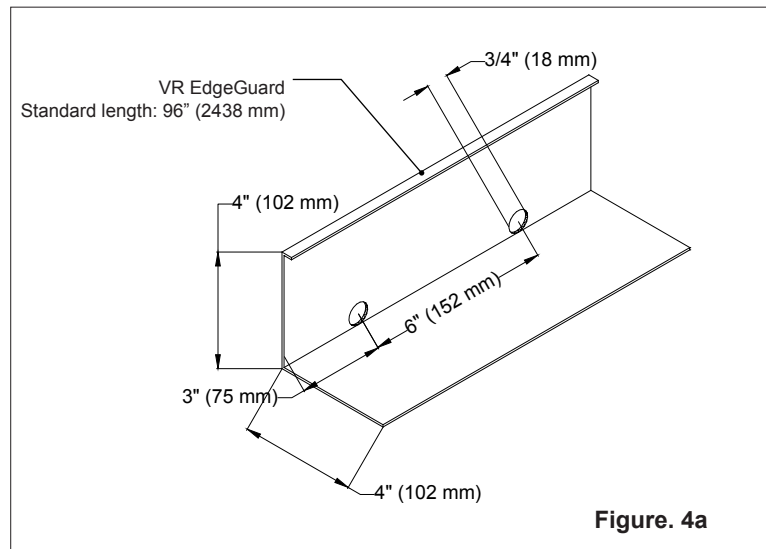
- a. Install VR DrainGuard centred over roof drains either on top of insulation (for inverted roofs) or VR PolyMat (for conventional roofs).
- b. Place lid over tabs, apply lock-out tags, ensuring they show the current date.



**Figure. 3a**

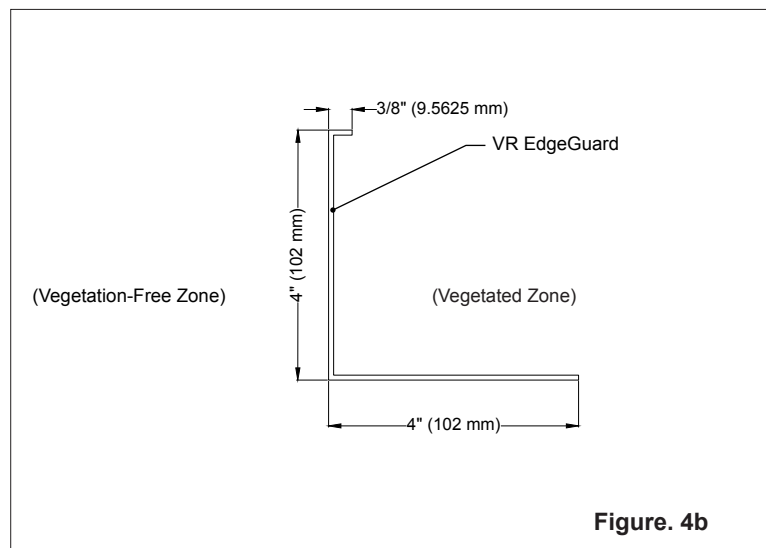
**4 Edging Restraint:  
 VR EdgeGuard**

- a. Install VR EdgeGuard along perimeter border between vegetation-free area and vegetated area as per plans and drawings.



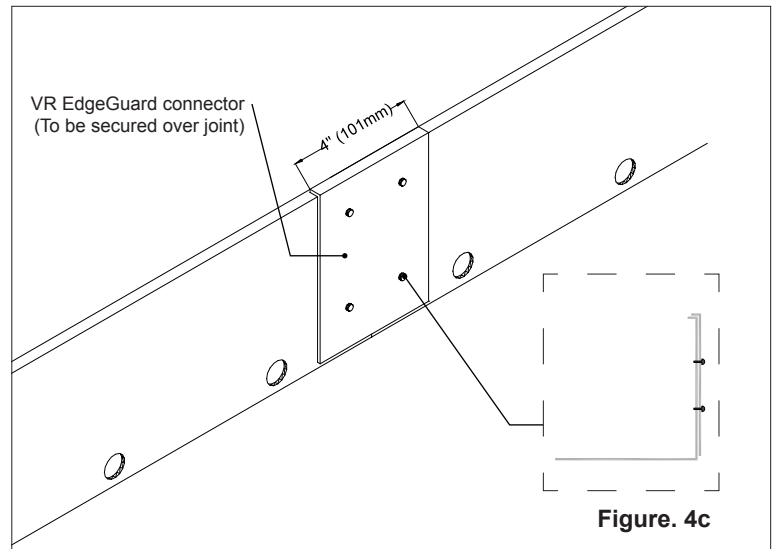
**Figure. 4a**

- b. Ensure flange of edging restraint is facing the vegetation.

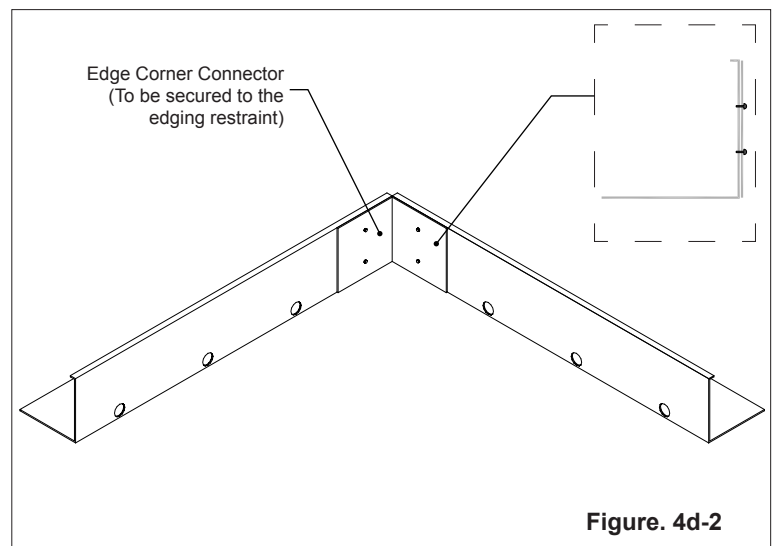
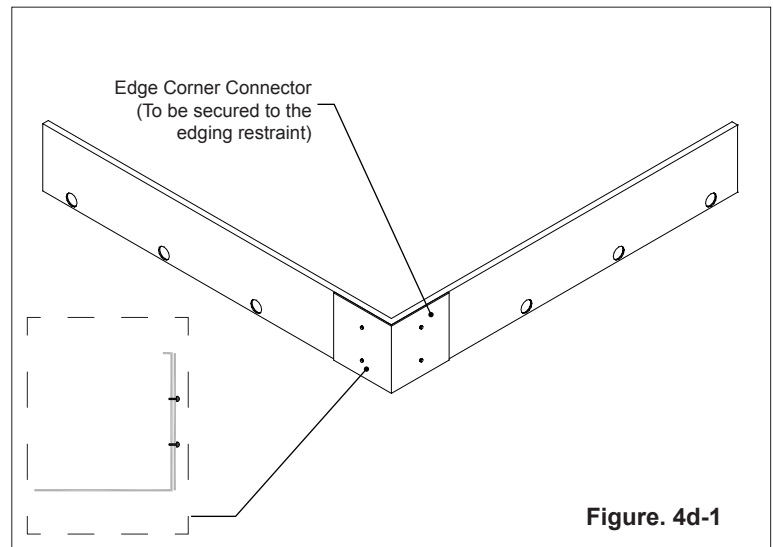


**Figure. 4b**

- c. When joining two sections together, ensure a tight fit at all joints. Place edge connector piece on vegetation-free side of edging restraint, making sure to overlap evenly with both ends of joints. Secure with self-tapping screws as per diagram. See Figure 4c.



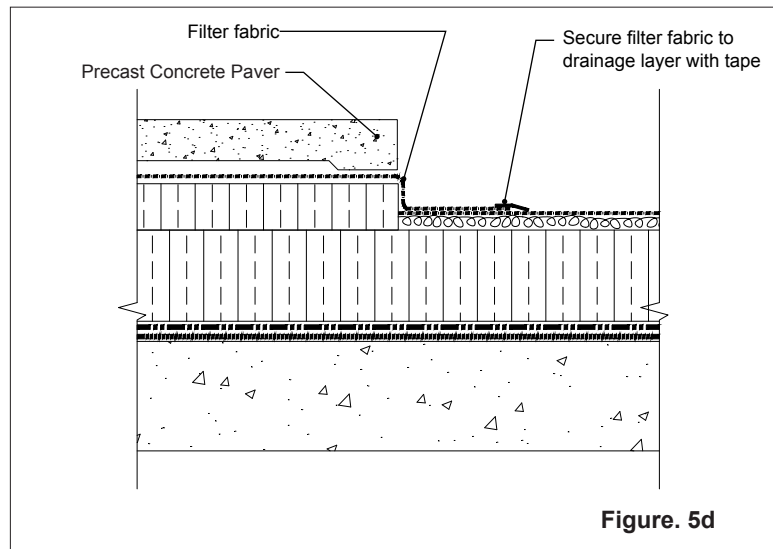
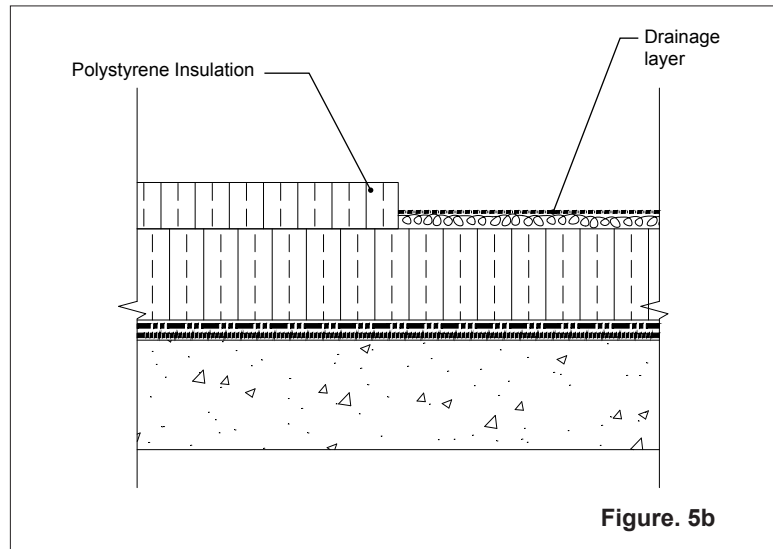
- d. Install corners after long sections. Miter flange and lip of edging restraints at corners. Place edge corner connector on vegetation-free side of edging restraint, at the corners. Secure corner piece with self-tapping screws as per diagrams. See Figure 4d-1 for outside corners and Figure 4d-2 for inside corners.



**5 Vegetation Free Zone Preparation  
 (Where no edging restraint is used)**

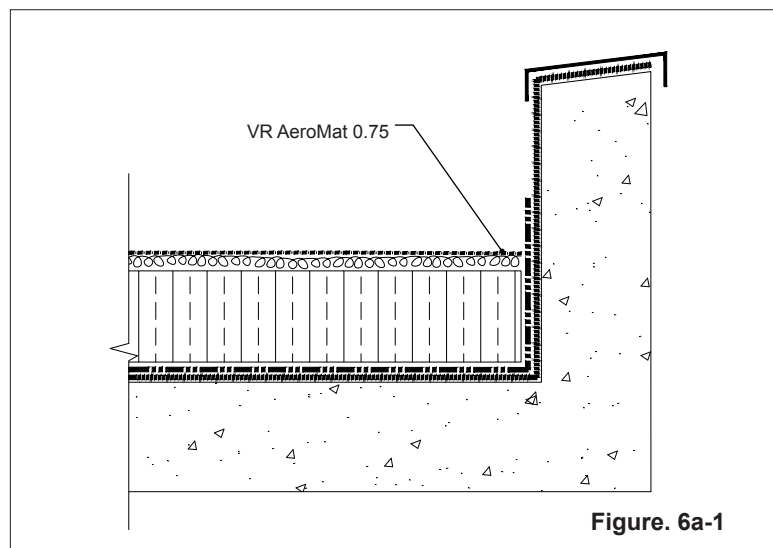
(NOTE: This installation method is an alternative to the standard method using VR EdgeGuard edging restraint. It may be used in addition to, or in place of, the standard vegetation-free zone installation method.

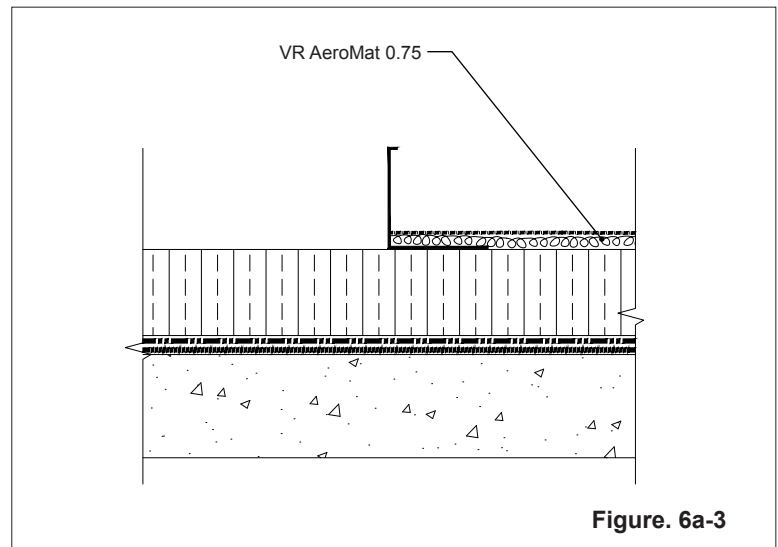
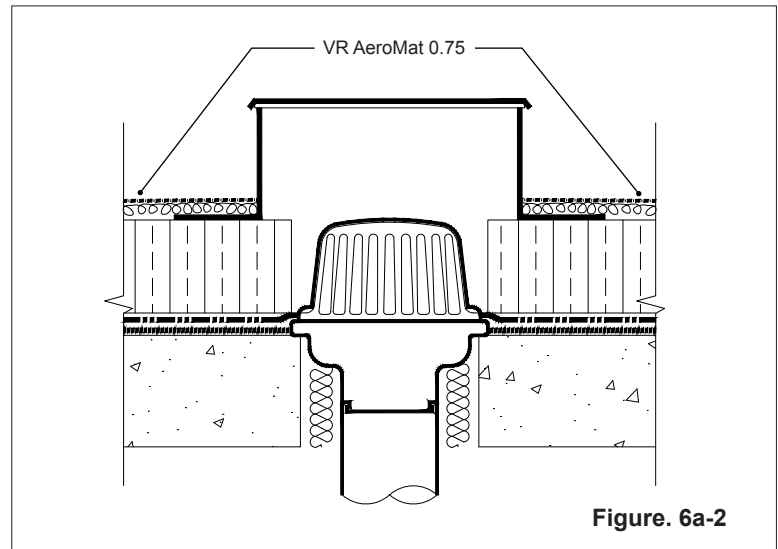
- a. Place an additional horizontal layer of 2" (50 mm) polystyrene insulation around the perimeter of the green roof area. Ensure the additional layer covers the entire vegetation free zone area.
- b. Lay VR AeroMat 0.75 rolls, fabric side up, and cut tightly at additional horizontal layer of polystyrene insulation.
- c. Bond one end of filter fabric to fabric surface of drainage layer with VR TecTape 2, Manufacturer's technical tape.
- d. Bring filter fabric up polystyrene, ensuring entire vegetation free zone is covered. Place paver on top.



**6 Drainage Layer:  
 VR AeroMat 0.75**

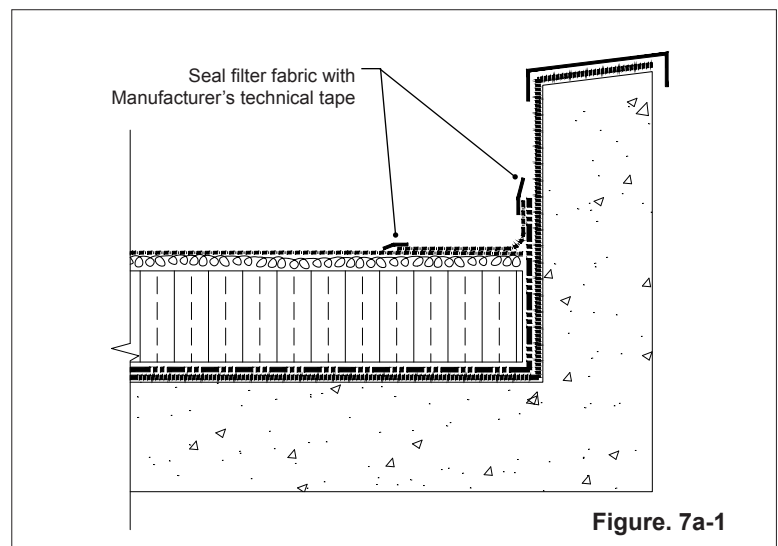
- a. Lay VR AeroMat 0.75 rolls, fabric side up, over the base layer of insulation.
- b. Butt sides and ends together using fabric end lap to overlap adjacent layers.
- c. Cut tightly around all vertical surfaces and projections (e.g. edging restraint, drains, parapets, etc).





**7 Filter Fabric:**  
**VR Filter Fabric**

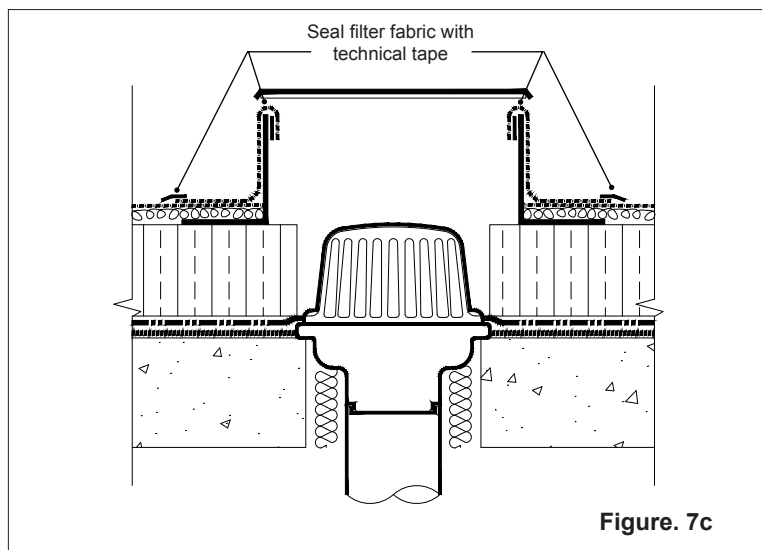
- a. Bond loose ends of filter fabric trim roll (from edging restraint and drain inspection box) to fabric surface of drainage layer with VR TecTape 2, Manufacturer's technical tape.
- b. Ensure 4 inches (100 mm) overlap for excess filter fabric.



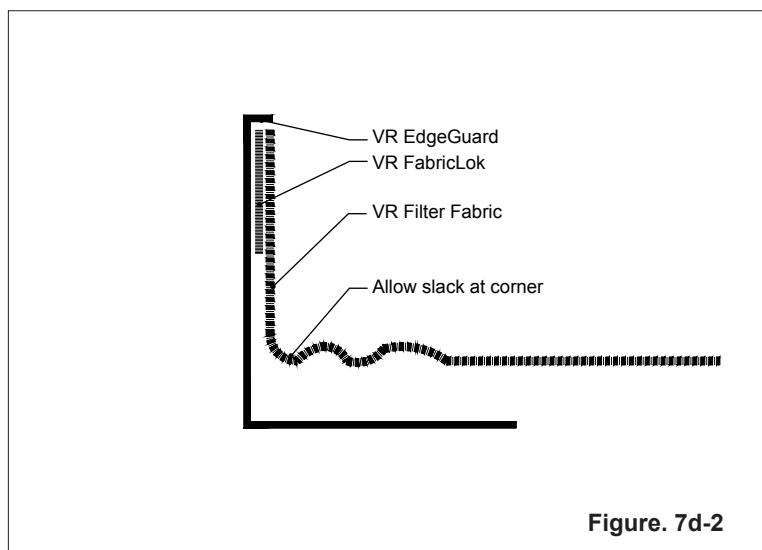
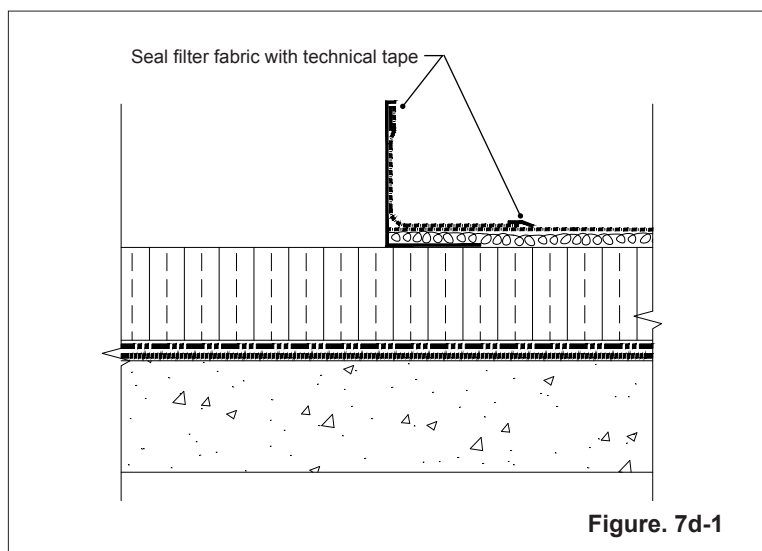
- c. At drain inspection boxes, wrap filter fabric along the walls of the box. Wrap edge of filter fabric over the lip of the box wall and adhere with manufacturer's technical tape.

At locking pins, cut slits in fabric to fit around locking pins. Adhere to top inside edge with manufacturer's technical tape.

Insert retaining pin into locking pin to lock lid of inspection box.



- d. At edging restraints, secure VR Filter Fabric to VR EdgeGuard with VR FabricLok. Allow for slack at the corner.

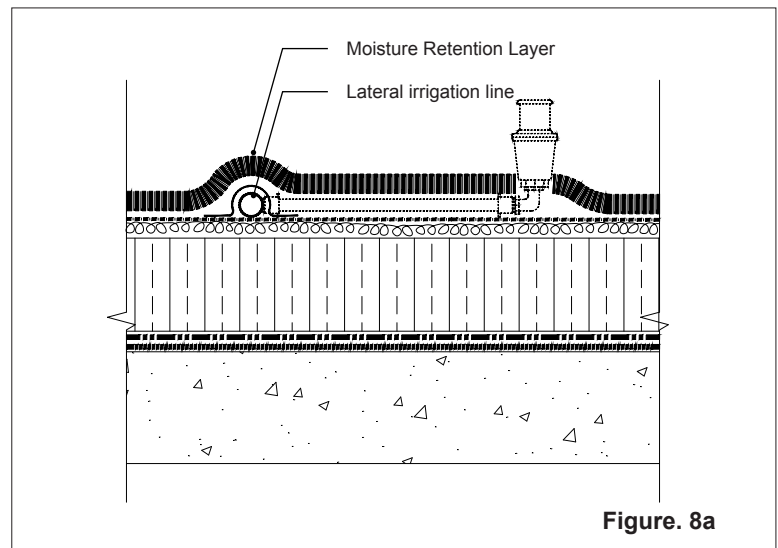




## 8 Irrigation System

(NOTE: If irrigation is not required proceed to Step 9. Install irrigation prior to installing moisture retention layer.)

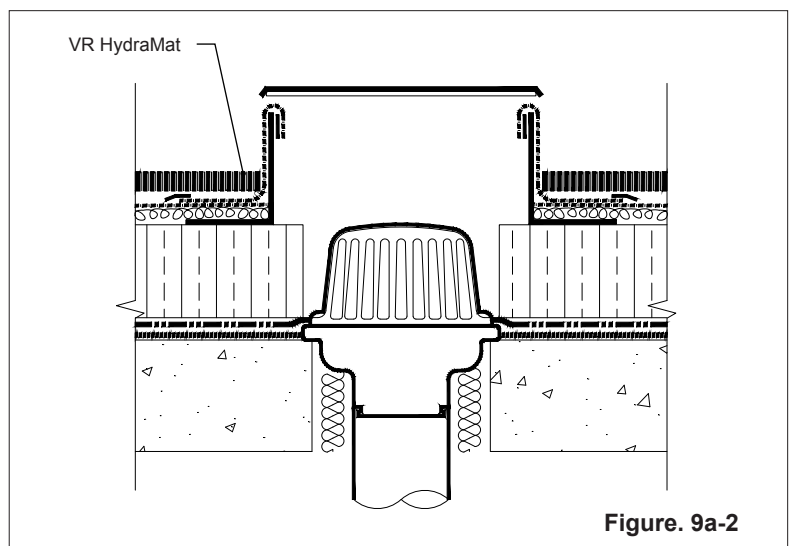
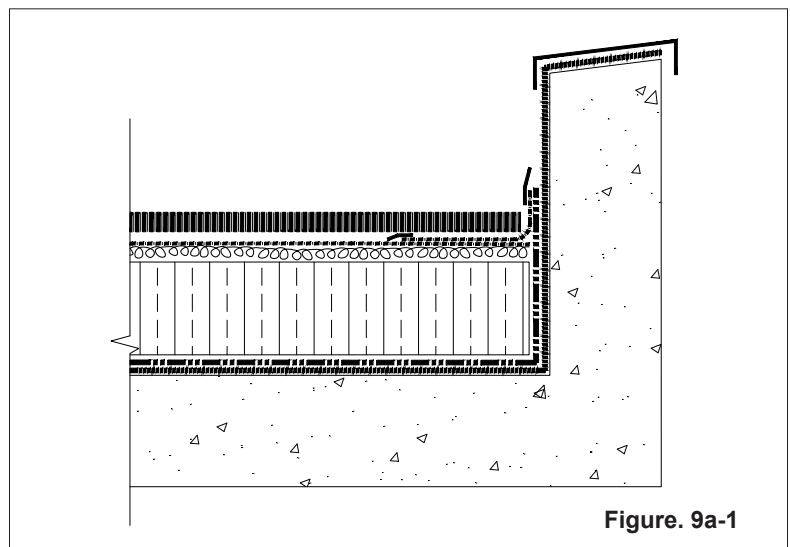
- a. Run rigid lateral lines over top drainage layer as per drawings.
- b. Place moisture retention layer on top, cutting holes for sprinkler heads.
- c. Place valves, valve boxes, controllers, etc... as per plans and drawings.



## 9 Moisture Retention Layer: VR HydraMat

- a. Install one layer of VR HydraMat on top of VR AeroMat 0.75. Each row of adjacent mats shall be offset by at least 6.5 ft (2 m) to avoid alignment of end seams across rows.

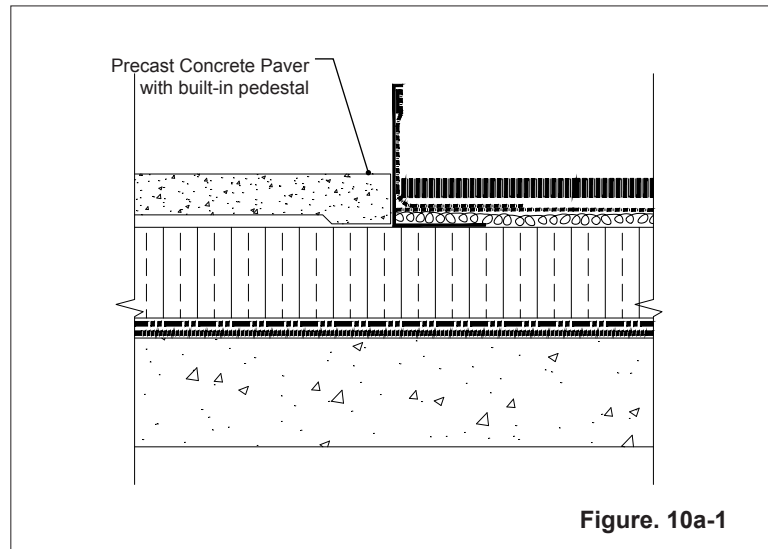
Cut tightly around any projections, drains, etc.



**10 Vegetation-Free Zone Pavers**

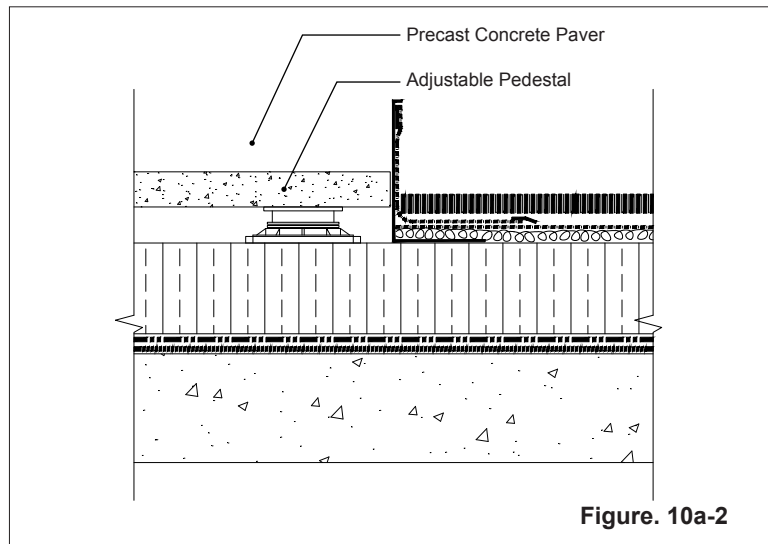
(OPTION 1: With built-in pedestal and edging restraint.)

- a. Place pavers tight against the VR EdgeGuard on top of the Insulation/Roofing System.
- b. Cut to fit as per plans and drawings.



(OPTION 2: With separate pedestal and edging restraint.)

- a. Place pavers on pedestals directly on top of Insulation/Roofing System. Ensure tight fit against the VR EdgeGuard.
- b. Level pedestals as required to make sure top of paver is flush with top of edging restraint.
- c. Cut to fit as per plans and drawings.



**11 Engineered Growing Media:  
VR HydraMix (Option 1: Bulk Bags)**

(NOTE: If installing via blower truck, proceed to Item 10 Option 2.)

- a. Crane bulk bags to rooftop, taking care to prevent overloading of the structure. The bulk bag is fitted with a chute at the base for convenient unloading once over the roof.

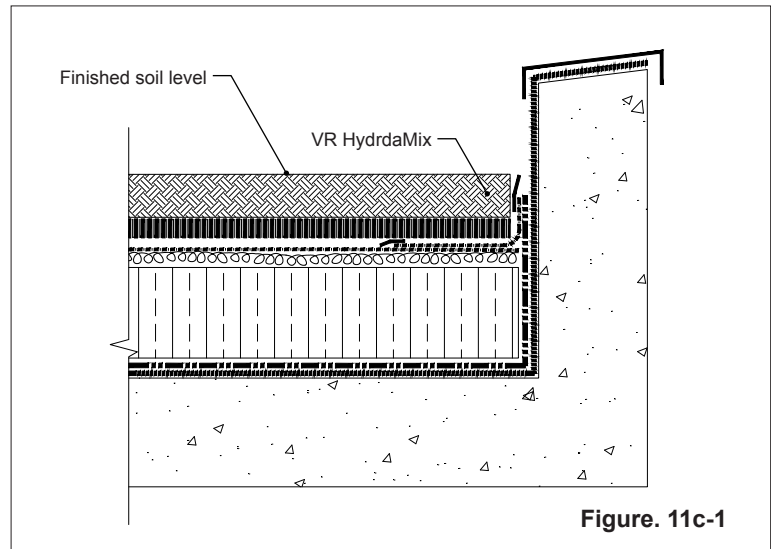
NOTE: The bulk bag provided by Tremco is a single use item.  
(DO NOT RE-USE BULK BAG FOR OTHER PURPOSES.)

- b. Remove the VR HydraMix and spread evenly over the designated areas of the green roof ensuring sufficient depth will be attained after compaction.

(NOTE: VR HYDRAMIX HAS AN APPROXIMATE COMPACTION FACTOR OF 30%.)

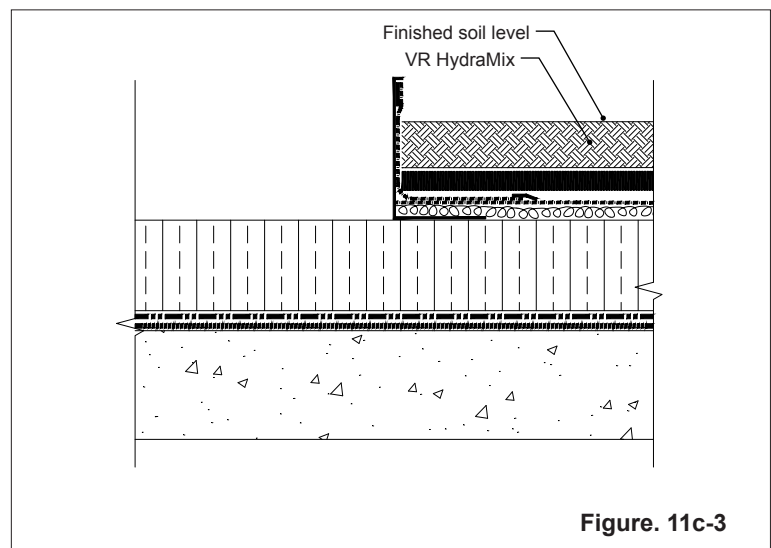
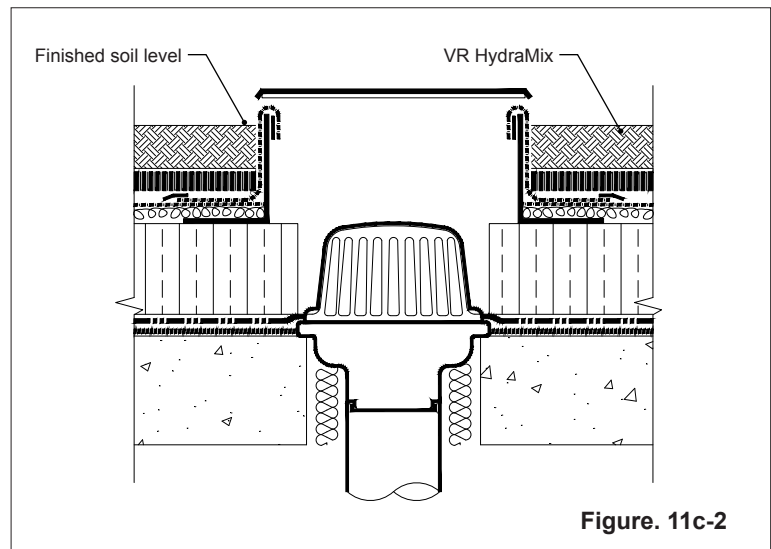
(NOTE: PREVENT DIRT POLLUTION IN VEGETATED FREE ZONE.)

- c. Lightly wet and then compact the VR HydraMix with a 55 pound (25 kilogram) hand roller. See Figure 9e-1, Figure 9e-2 and Figure 9e-3.



**11 Engineered Growing Media:  
VR HydraMix (Option 2: Blower Truck)**

- a. Blower Truck Minimum Requirements:
  - Must be a truck-mounted, integrated, pneumatic blower unit.
  - In order to ensure accuracy, the unit should be powered by its own separate diesel power unit, not PTO driven, and equipped with at least one computer-controlled supplemental granular injection system.
  - Injection system must calculate according to RPMs of the internal airlock feeder and not percentages, in order to ensure accuracy of injection rates.
  - The unit must be capable of uniformly applying materials and injected products at a rate greater than 15 yd<sup>3</sup>/hour (11 m<sup>3</sup>/hour) at least to a vertical limit 150 feet (45 m) and must also be equipped with an application hose capable of extending 300 feet (91 m) from the blower truck.
- b. Ensure VR HydraMix is spread evenly over the designated areas of the green roof ensuring sufficient depth will be attained after compaction.



- c. (NOTE: VR HYDRAMIX HAS AN APPROXIMATE COMPACTION FACTOR OF 30%.)  
(NOTE: PREVENT DIRT POLLUTION IN VEGETATION FREE ZONE.)

Lightly wet and then compact the VR HydraMix with a 55 pound (25 kilogram) hand roller.

**12 Vegetation:**  
**Sedum mat**

- a. Install the pre-cultivated vegetation mat on top of the growing media. Offset vegetation mats by half the length of an individual mat to avoid alignment of end seams across rows. Cut to fit along roof edge and around penetrations.
- b. After installation of mats, redistribute and/or supplement the substrate accordingly to ensure even coverage across vegetation mats. In areas or alongside edges where substrate is lost during transport and handling, new substrate must be added to support vegetative growth.
- c. Water the assembled vegetation system immediately and thoroughly after installation to assist with settling of system layers and to support vegetation establishment.

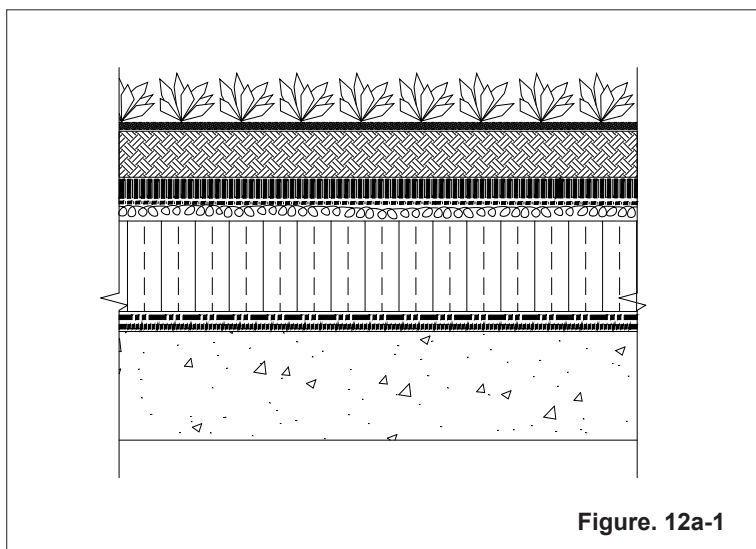


Figure. 12a-1

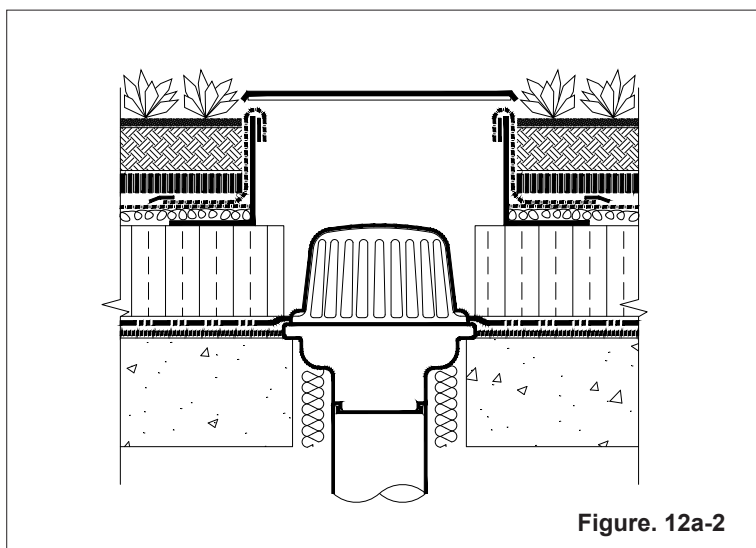


Figure. 12a-2

